

POMPES AUTOAMORÇANTES FONTE



Données techniques

Exécution

Pompes autoamorçantes à jet avec éjecteur incorporé.

Utilisations

- Pour l'approvisionnement en eau avec l'aspiration de puits.
- Pour augmenter la pression du réseau de distribution (*observer les prescriptions locales*).
- Pour liquides propres sans particules abrasives, non agressifs.
- Pour le jardinage.
- Pour laver au jet d'eau.

Limites d'utilisations

Température du liquide de : 0°C à + 40°C.

Température ambiante jusqu'à + 40°C.

Pression maximale admissible dans le corps de pompe : 10 bars.

Hauteur d'aspiration maxi : 9 mètres

(NG 32 avec hydro-éjecteur intégré : 16 mètres).

Service continu.

Construction

Composant	Matériaux
Corps de pompe	Fonte GJL 200 EN 1561
Couvercle avec lanterne	
Flasque du diffuseur	
Roue	Laiton P-Cu Zn 40 Pb 2 UNI 5705
Arbre	Acier au Cr 1.4104 EN 10088 (AISI 430) pour NG 3-4 Acier au Cr-Ni 1.4305 EN 10088 (AISI 303) pour NG 5-6-7-32
Corps Ejecteur NG32	Fonte GJL 200 EN 1561
Diffuseur	PPO-GF20 (Noryl)
Embouchure	PPO-GF20 (Noryl) (Laiton P-Cu Zn 40 Pb 2 UNI 5705 pour NG 32)
Garniture mécanique	Carbone dur / Céramique / NBR

Moteur

Moteur à induction 2 pôles, 50Hz ($n=2900$ trs/min).

NG : triphasé 230/400 V \pm 10%.

NGM : monophasé 230 V \pm 10%, avec protection thermique.

Isolation classe F.

Protection IP 54.

Moteur triphasé haut rendement IE2 de 0,75 à 2,20 kW.

Exécution selon : EN 60034-1; EN 60034-30;

EN 60335-1; EN 60335-2-41.

Exécutions spéciales sur demande

- Autres voltages.
- Fréquence 60 Hz.
- Protection IP 55.
- Garniture mécanique spéciale.



NG



NG 32

Courbes hydrauliques $n \approx 2900$ trs/min avec hauteur d'aspiration $H_s = 1$ m

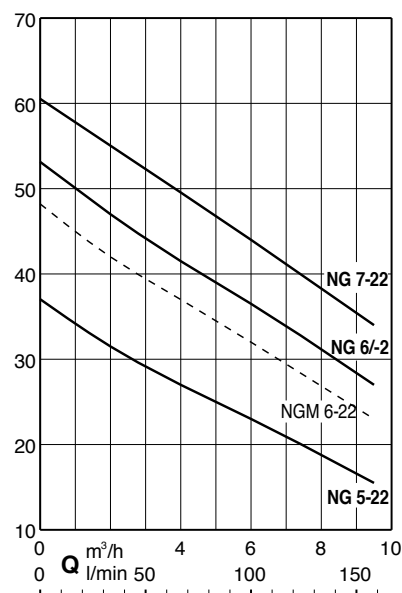
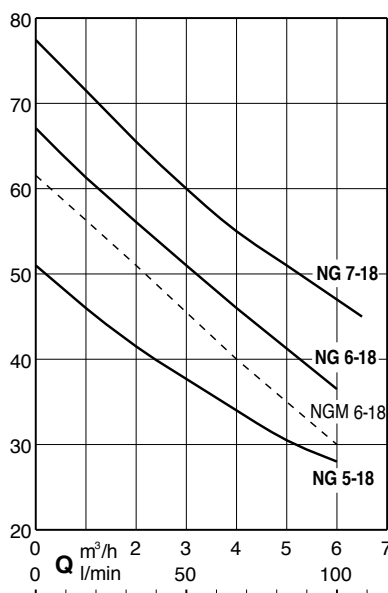
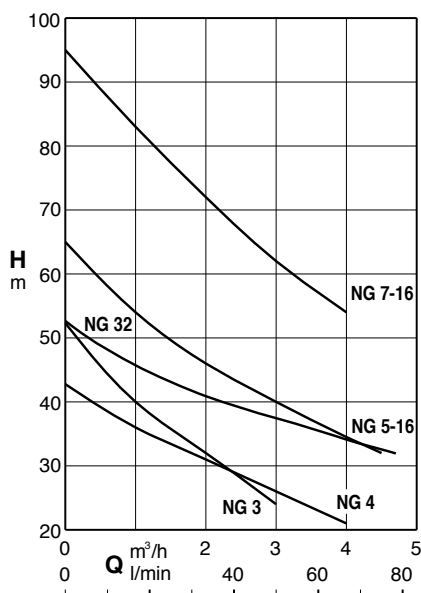

Courbes hydrauliques n ≈ 2900 trs/min

Référence	MOTEUR			m³/h l/min	0.25	0.5	1	1.5	2	2.5	3	4	4.5	5	6	
	Tension	kW	A		4.1	8.3	16.6	25	33.3	41.6	50	66.6	75	83.3	100	
NG 3	400	0.55	1.7	H m	49	45.5	40	36	32	28	24	-	-	-	-	
NGM 3	230		4.5													
NG 4	400	0.75	2.2		41	39	36	33	31	29	26	21	-	-	-	-
NGM 4	230		5.7													
NG 32	400	1.10	2.7		-	49	46	43.5	41	39	38	34	33	31	-	-
NGM 32	230		7.4													
NG 5-16	400	1.10	2.7		-	59	54	50	46	43	40	34.5	32	-	-	-
NGM 5-16	230		7.4													
NG 5-18	400	1.10	2.7		-	48.5	46	43.5	41.5	39.5	38	34	32	30.5	28	-
NGM 5-18	230		7.4													
NG 6-18	400	1.50	4.3		-	64.5	62	59	56	54	51	46	43.5	41.5	36.5	-
NGM 6-18	230		9.2													
NG 7-16	400	2.20	5.3		-	89	83	77	72	67	62	54	-	-	-	-

Référence	MOTEUR			m³/h l/min	0.5	1	2	2.5	3	4	4.5	5	6	7	8	9.5	
	Tension	KW	A		8.3	16.6	33.3	41.6	50	66.6	75	83.3	100	116.6	133	158	
NG 5-22	400	1.10	2.7	H m	35.5	34.5	31.5	30.5	29.5	27	26	25	23	20.5	18.5	15.5	
NGM 5-22	230		7.4														
NG 6-22	400	1.50	4.3		51.5	50	47	46	44.5	41.5	40	39	36.5	33.5	31	27	
NGM 6-2	230		9.2														
NG 7-18	400	2.20	5.3		74.5	71.5	65.5	63	60	55	53	51	47	-	-	-	
NG 7-22	400		5.3														
					59	57.5	55	54	52.5	50	48.5	47	44	41.5	38	34	-

Exemples d'installation

Fonctionnement en charge

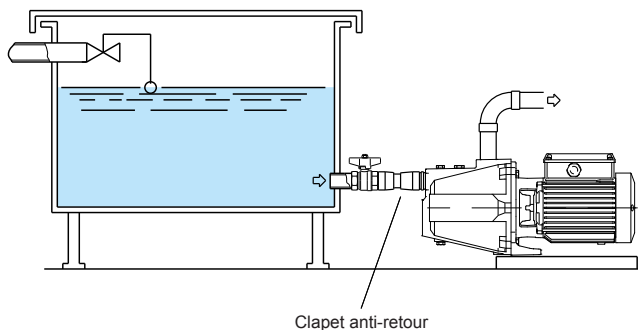

Fonctionnement en aspiration

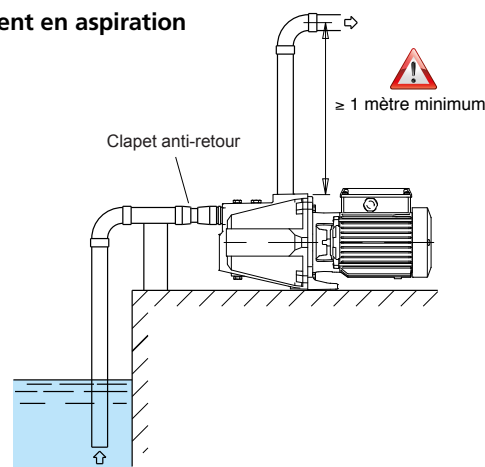

Dimensions et poids

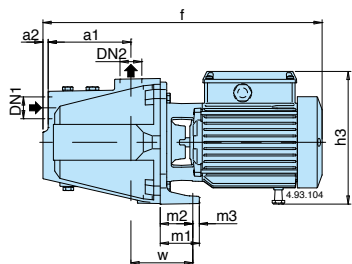

NG 3, 4, 5, 6, 7

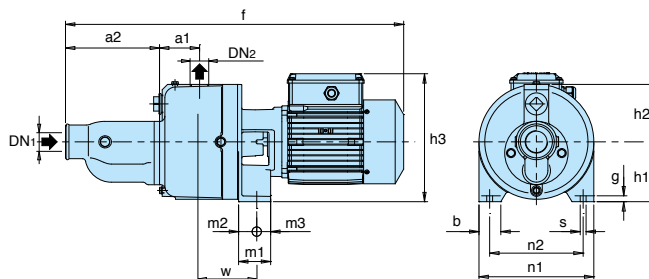

NG 32

Référence	DN1	DN2	Dimensions mm														Poids kg	
	ISO 228		a1	a2	f	h1	h2	h3	m1	m2	m3	n1	n2	b	s	w	g	NG
NG 3	G 1"	G 1"	127	8	430	150	43	207	60	52	8	185	155	35	9.5	100	11	18.4
NG 4	(26/34)	(26/34)																19.2
NG 5	G 1 1/2"	G 1"	160	10	560	165	57	197	60	50	10	215	175	40	11.5	115	11	29.2
NG 6			600															30.8
NG 7			600															
NG 32			75	175	557	112	108	222	60	34	26	215	175	40	11	106	10	38

Courbes hydrauliques $n \approx 2900$ trs/min

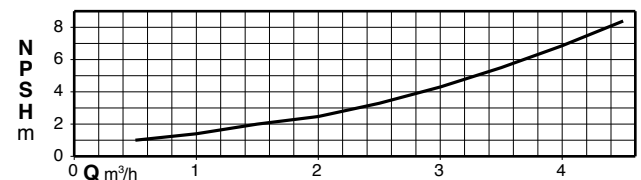
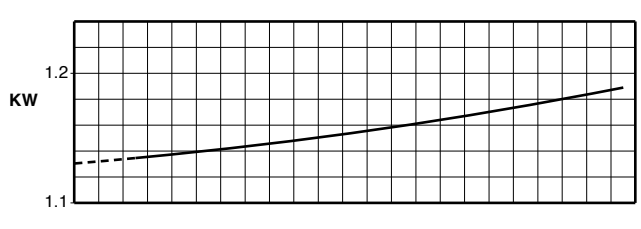
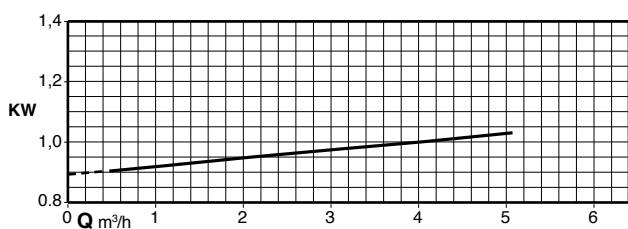
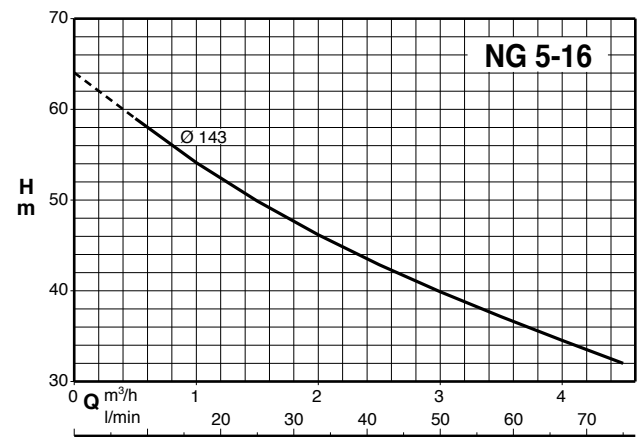
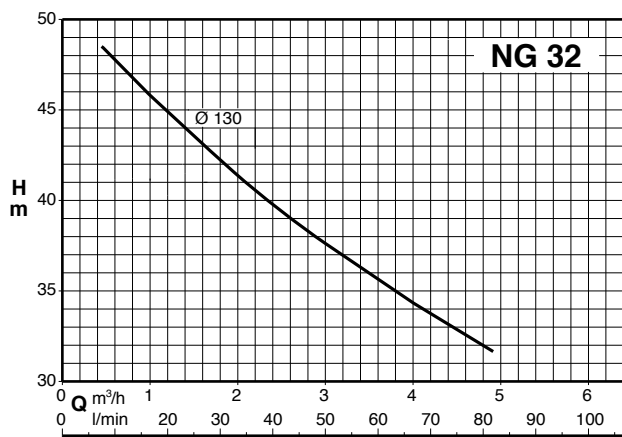
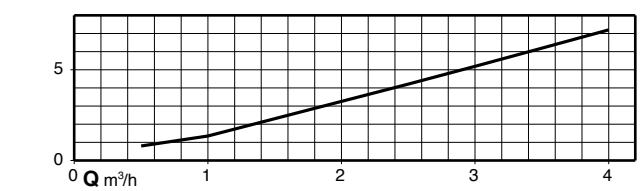
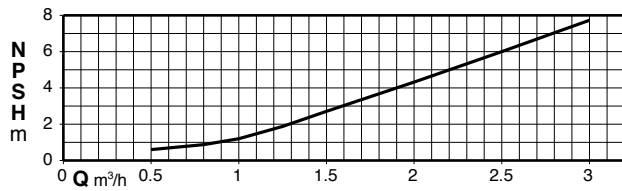
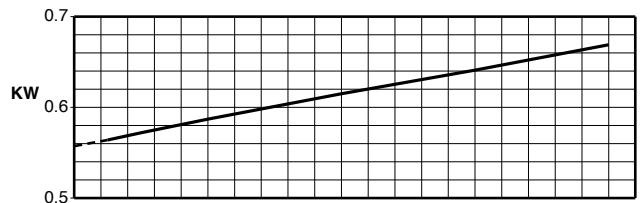
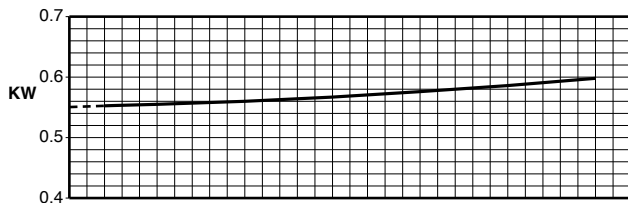
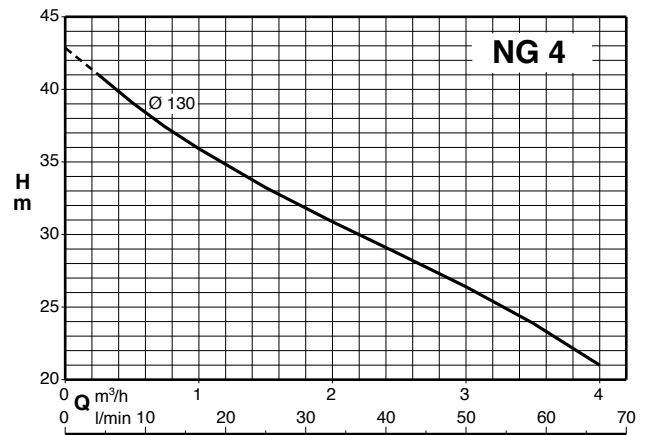
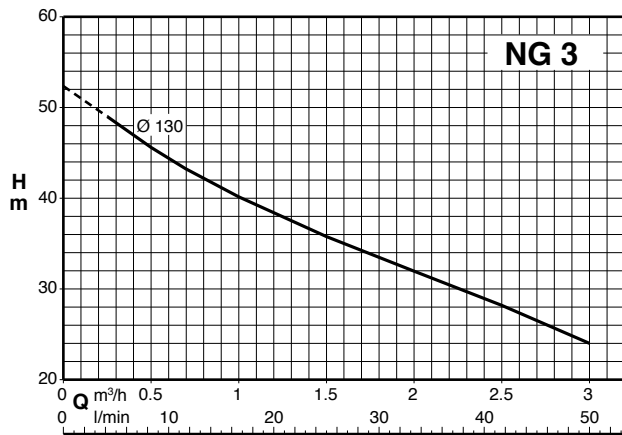

Courbes hydrauliques $n \approx 2900$ trs/min

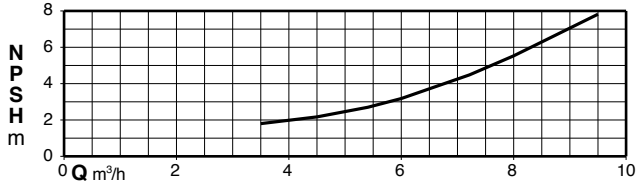
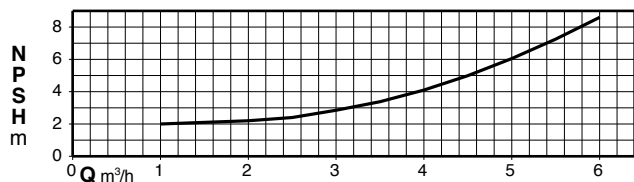
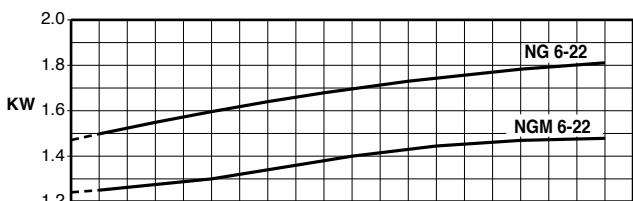
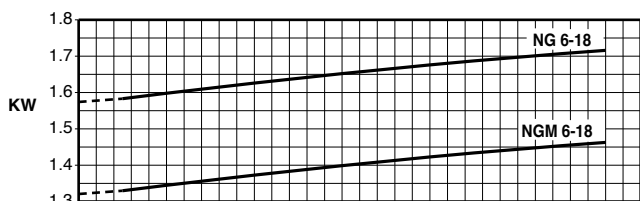
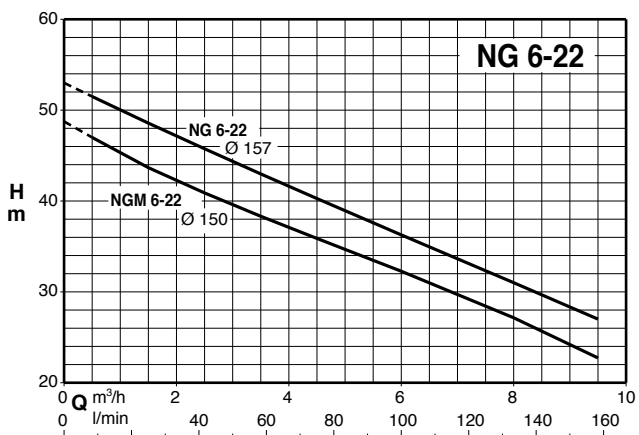
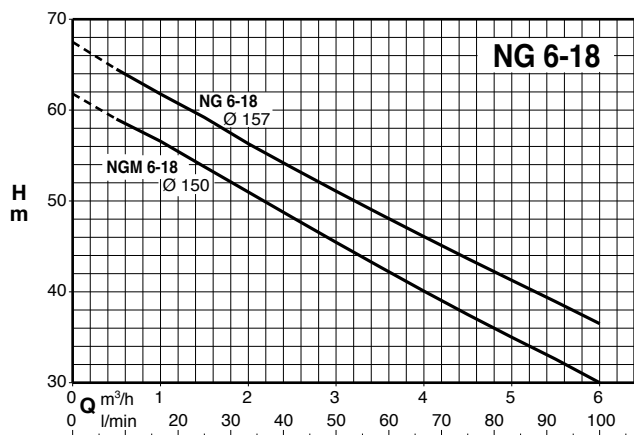
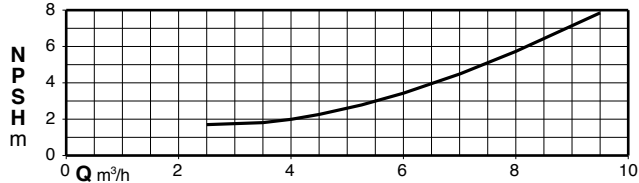
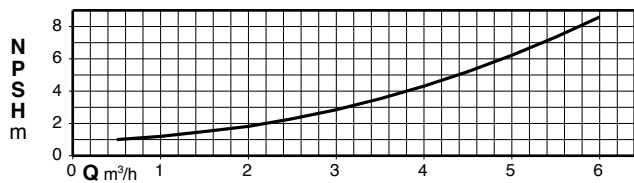
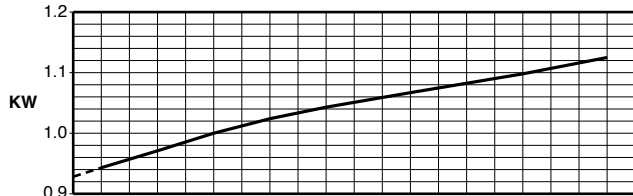
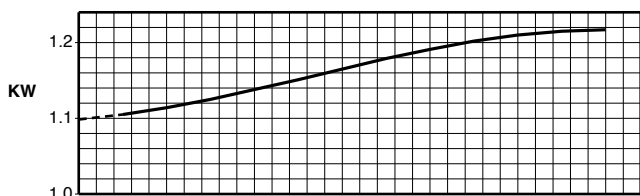
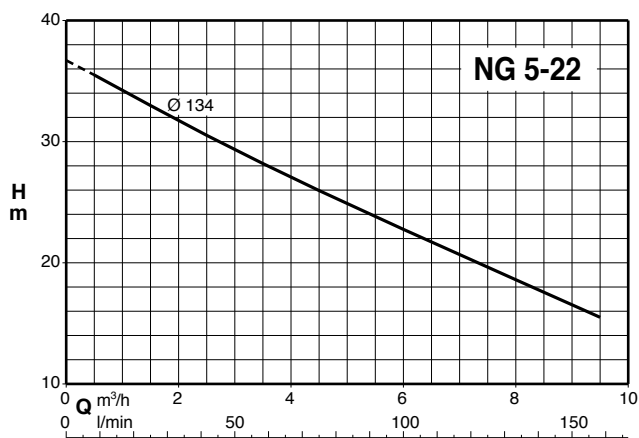
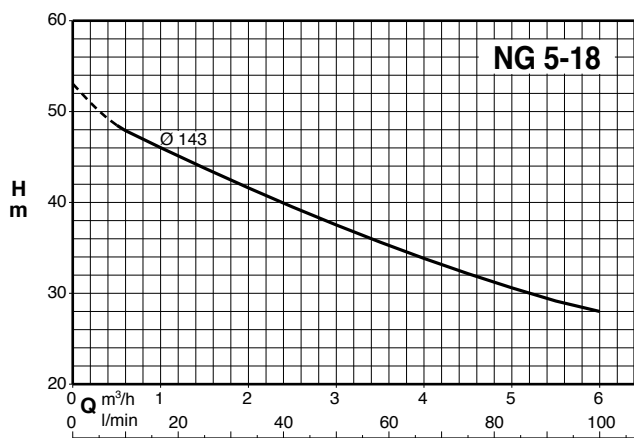

Courbes hydrauliques $n \approx 2900$ trs/min

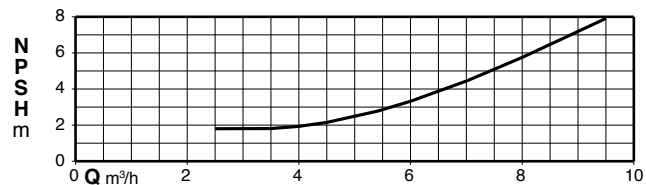
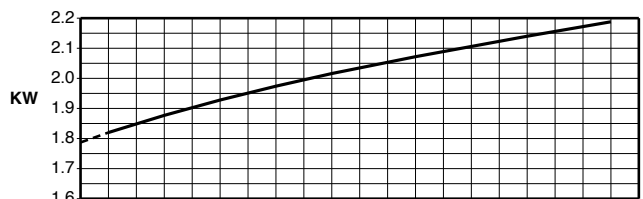
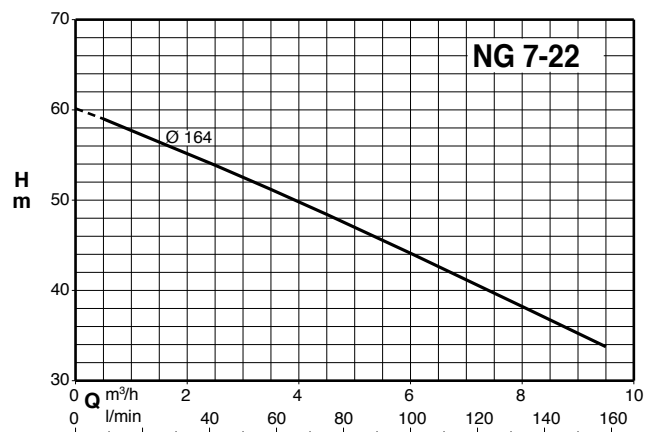
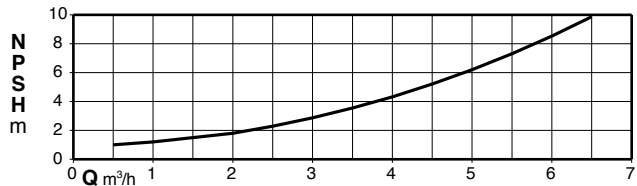
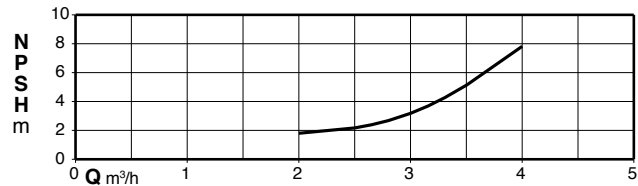
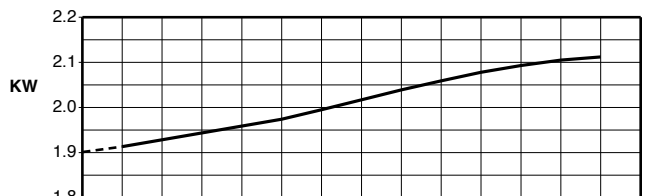
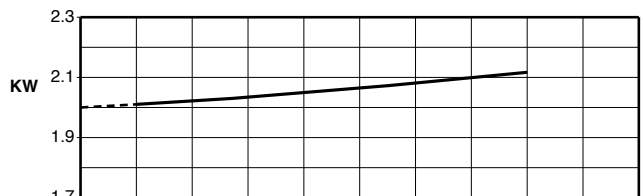
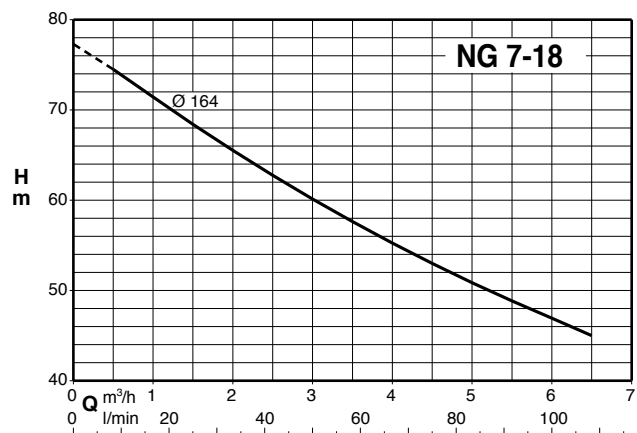
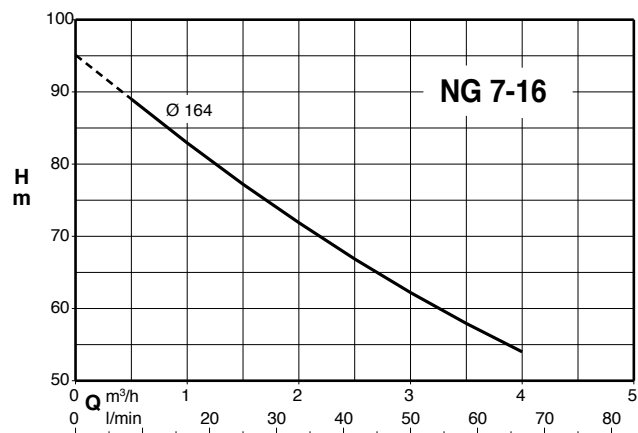

Caractéristiques de construction

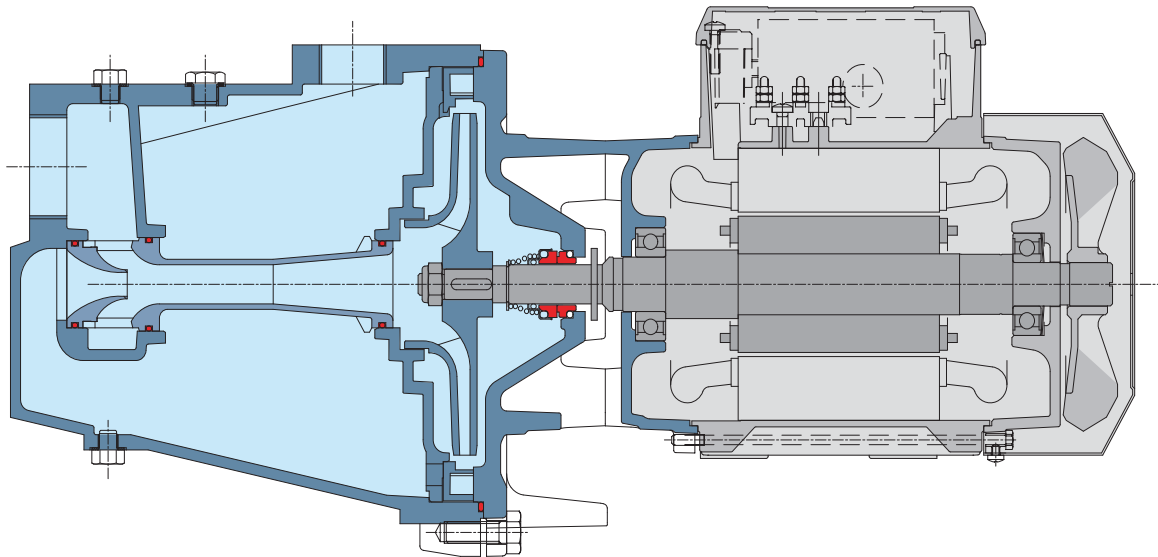

Construction robuste

La structure mécanique, ainsi que les matériaux choisis pour les parties en contact avec le liquide pompé assurent un maximum de résistance aux sollicitations mécaniques.

Auto-amorçage

La structure hydraulique permet l'amorçage des pompes face à des hauteurs d'aspiration importantes ou en présence de tuyauterie de longueur importante au dessus du niveau de l'eau.

Fiabilité d'utilisation

Pour les parties en contact avec le liquide pompé il est possible de choisir la fonte ou le bronze ce qui permet l'emploi des pompes pour le pompage de liquides divers.

Dessin exclusif

Pour la sécurité des utilisateurs un nouveau dispositif de protection empêche le contact avec les parties rotatives de la pompe et permet un accès aisé à la garniture mécanique.

**FABRICANT
DEPUIS 1959**



ITALIE

Calpeda S.p.A.

Via Roggia di Mezzo 39,
36050 Montorso Vicentino - Vicenza
Tel. +39 - 0444 476 476
Fax +39 - 0444 476 477



**À VOTRE SERVICE
DEPUIS 27 ANS**



FRANCE

Calpeda Pompes

19, rue de la communauté - ZA La Forêt - 44140 LE BIGNON
Tél. 02 40 03 13 30 - Fax 02 40 03 16 70
e.mail : info@calpeda.fr - Site : www.calpeda.fr



Calpeda Pompes

19, rue de la communauté - ZA La Forêt - 44140 LE BIGNON
Tél. 02 40 03 13 30 - Fax 02 40 03 16 70 - email : info@calpeda.fr - www.calpeda.fr

SAS au capital de 1 030 000 € - RCS Nantes B 322 698 093 - Siret 322 698 093 00059 - Code NAF 4669B - N° TVA intra communautaire : FR50322698 093



water passion

NG - CALPEDA (Doc). Document non contractuel et non définitif, soumis à modifications. Calpeda France se donne le droit à toute rectification concernant la présente documentation.